

EVOLUTION ELECTRIC VEHICLES, INC. has a policy of improving products continuously. All the information in this catalogue is provided for reference only. In order to insure all the information is correct, there may be changes to make according to improvements of the products at the time of printing, we reserve the right to make corrections as well as product alterations and improvements at any time without notice. Trademarks are the property of EVOLUTION ELECTRIC VEHICLES, INC. or their respective owners.

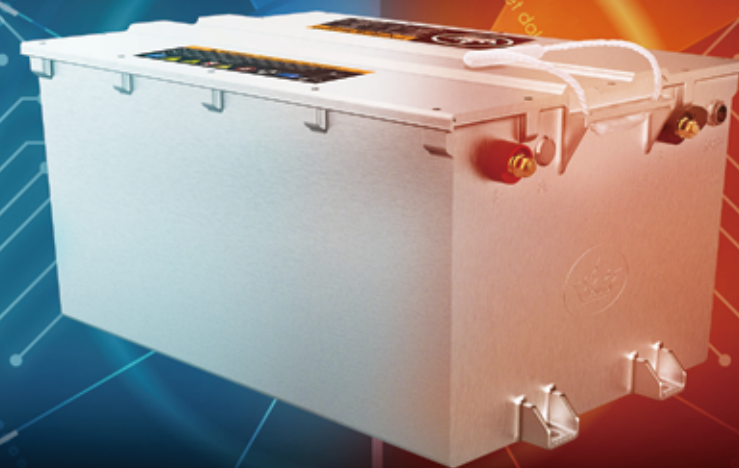

LITHIUM

BATTERY



GOLF CART

LIFEPO4 BATTERY

- ULTRA SAFE
- NO MAINTENANCE
- ALUMINUM PACK
- 5-YEAR WARRANTY



EVOLUTION ELECTRIC VEHICLES INC
California Headquarters: 2620 Palisades Drive, Corona CA 92882
Florida Operations: 7600 Narcoossee Rd, Orlando, FL 32822
909-393-6800 info@evolutionelectricvehicle.com
www.evolutionelectricvehicle.com

V1.2



EVOLUTION ELECTRIC VEHICLES INC

ALL RIGHTS RESERVED BY EVOLUTION ELECTRIC VEHICLE

Contents

- 01** About Us
- 02** Company Strength
- 03/04** Advantages of LFP Golf Cart Battery
- 05/06** LFP Golf Cart Battery -L Series
- 07/08** Battery Specifications
- 09** BMS Specifications
- 10** BMS Comparison
- 11** Aluminum Pack
- 12** Iron vs. Aluminum Casing
- 13/14** Lead-acid vs. Lithium-ion Battery
- 15** LFP Golf Cart Battery Warranty
- 16** Battery Charger

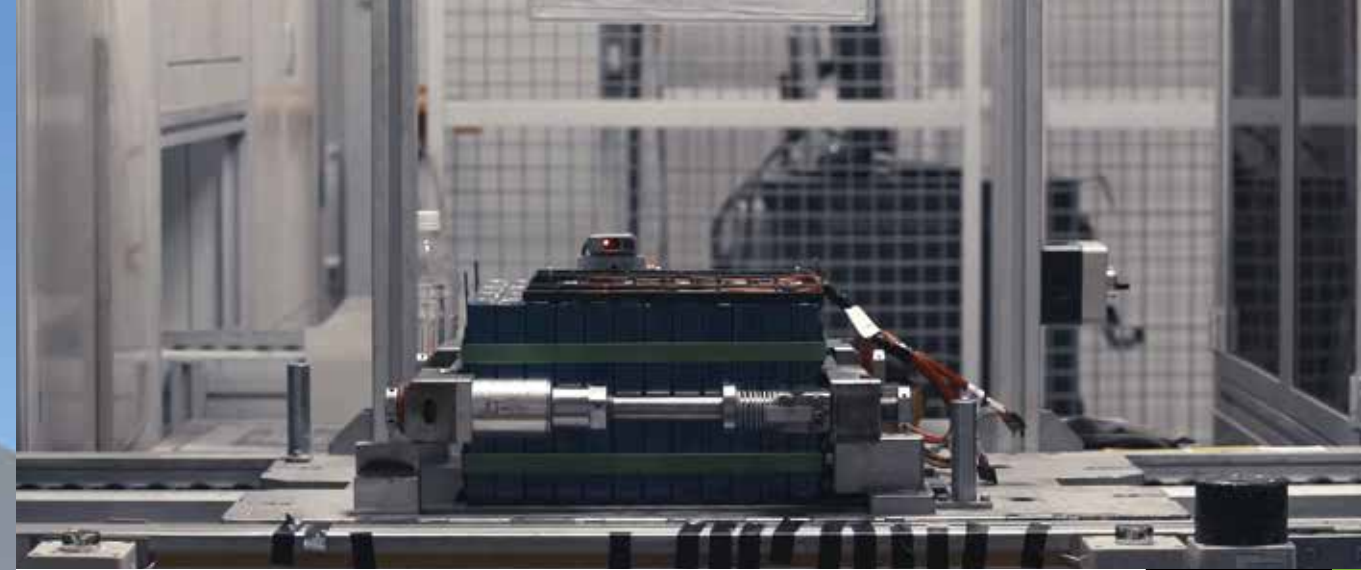

Evolution Electric Vehicles manufacturers small-wheel, zero-emission electric vehicles and lithium-ion battery packs. The Company distributes electric golf cars & batteries for recreational use and off-road utility vehicles for golf, commercial and industrial use. Founded in 2006, Evolution headquartered in California and established a branch office in Florida. Evolution serves the customers in global markets since Evolution has over 200 dealers & distributors all over the world. Our network provides a complete end-to-end business solution, prompt and efficient service and support, great warranty experience to customers.

In order to provide better services in the American market, we've set up 2 facilities in the United States to meet and satisfy the needs of our customers, to offer fast delivery and to provide solutions in time.

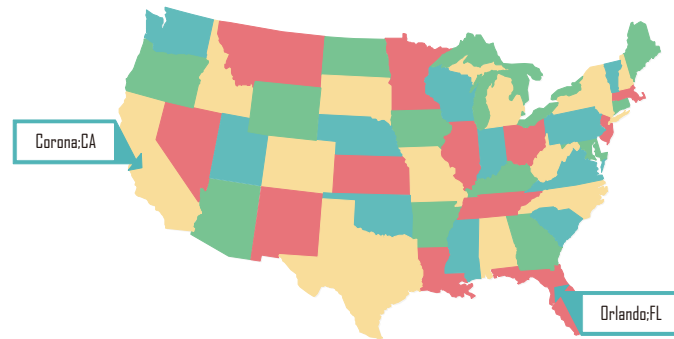

Florida Operations: 7600 Narcoossee Rd, Orlando, FL 32822



California Headquarters: 2620 Palisades Drive, Corona CA 92882

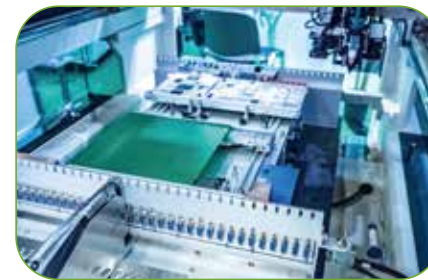

R&D and Test Centers

- Safety
- Chemical
- Environment
- Electrical performance

Manufacture

- 500 staff
- 3 factories
- Advanced equipments
- Cutting-edge technology





Half of the size and 1/4 of the weight take a load off the turf, protecting one of the customers' most valuable assets. The lighter weight also means the golf cart can reach higher speeds with less effort and carry more.



Free Maintenance. No waterfilling, no terminal tightening and cleaning of acid deposits on the top of our batteries.



Our LiFePO4 battery capacity is over 80% left after 1C charge & discharge under 100%DOD condition and 3500 cycles. Its design life is up to 15 years while the lead-acid battery can only cycle 500 times at 80%DOD.



Top notch BMS system allows batteries to discharge in deeper/higher current compared to our competitors.



Long-lasting aluminum casing. Rust resistant, Water-proof, Light weight, Impact resistant. Better heat dissipation. Longer life expectancy.



Our LiFePO4 batteries have high discharge voltage platform(above 51V) and stable discharge curve. It requires less energy, less grid power and less charging time than lead-acid batteries, which leads to less energy costs.



We offer a 5-year warranty to ensure the professional technical support and replacement for Evolution LiFePO4 golf cart batteries. Please turn to page 11 to check the detailed terms.



It contains multiple built-in protection functions: over charge protection, over discharge protection, over heated protection, short circuit protection., etc.



The quick-charging time is ONE hour for 80% charged and the standard charging time is 4-5 hours for fully charged.



The lithium-ion battery is environmentally friendly. No emission of toxic and hazardous chemicals. No lead evaporation. No hydrogen during charging. Less turf compaction due to lower weight.

L series products are lithium-ion battery packs with integrated golf cart battery system.

They are designed to replace the lead-acid batteries and are available for drop-in replacement in Club Car, EZ-GO, Yamaha.,etc, vehicles easily.

SUITABLE FOR ALL TOP BRAND GOLF CARTS !

Product specification

 L series	L4860	L48110
Technical specification		
Nominal voltage	51.2V	51.2V
Nominal capacity	60Ah	110Ah
Stored energy	2.88kwh	5.28kwh
Life cycles	>3500 times	>3500 times
Self discharge	max 3.2% per month	max 3.2% per month
Mileage (2 seat at 13mph)	25-35miles/full charging	40-55miles/full charging
Continuous charge current	≤40A	≤70A
Continuous discharge current	100A	100A
Maximum discharge current	3C(30s)	3C(30s)
Quick charging time	1h	1-2h
Standard charging time	3-4h	4-5h
Charge temperature range	32°F to 110°F (0°C to 45°C)	32°F to 110°F (0°C to 45°C)
Discharge temperature range	-4°F to 140°F (-20°C to 55°C)	-4°F to 140°F (-20°C to 55°C)
Storage temperature range	-4°F to 113°F (1month)(-20°C to 45°C) 32°F to 95°F (1year)(0°C to 35°C)	-4°F to 113°F (1month)(-20°C to 45°C) 32°F to 95°F (1year)(0°C to 35°C)
General specification		
Cell combination	16 in series circuit	16 in series circuit
Cell assembly	3.2V60Ah	3.2V110Ah
Casing material	Aluminum Alloy	Aluminum Alloy
Weight	56.8lbs(25.8kg)	102.7lbs(46.6kg)
Dimension(L*W*H)	12.8*12.8*9.1in	21.0*13.8*9.8in
IP rate	IP66	IP66

Note:

1. Only authorized personnel is allowed to operate or make adjustments to the battery.
2. Must to use Evolution original chargers and accessories with our batteries.
3. Specifications in this catalogue are subject to change without notice. Please contact EVOLUTION ELECTRIC VEHICLES,INC. for detailed information.

The advantages of lithium-ion battery include lighter weight, shorter charging time, longer life, free maintenance and lower electricity bills . Our battery has an integrated management system which includes an On/Off switch and a state-of-charge(SOC) gauge.

SUITABLE FOR ALL TOP BRAND GOLF CARTS !

Product specification

 L series	L48130	L48180
Technical specification		
Nominal voltage	51.2V	51.2V
Nominal capacity	130Ah	180Ah
Stored energy	6.24kwh	8.64kwh
Life cycles	>3500 times	>3500 times
Self discharge	max 3.2% per month	max 3.2% per month
Mileage (2 seat at 13mph)	45-55miles/full charging	55-75miles/full charging
Continuous charge current	≤75A	≤126A
Continuous discharge current	100A	100A
Maximum discharge current	3C(30s)	3C(30s)
Quick charging time	1-2h	2-3h
Standard charging time	4-5h	6-8h
Charge temperature range	32°F to 110°F (0°C to 45°C)	32°F to 110°F (0°C to 45°C)
Discharge temperature range	-4°F to 140°F (-20°C to 55°C)	-4°F to 140°F (-20°C to 55°C)
Storage temperature range	-4°F to 113°F (1month)(-20°C to 45°C) 32°F to 95°F (1year)(0°C to 35°C)	-4°F to 113°F (1month)(-20°C to 45°C) 32°F to 95°F (1year)(0°C to 35°C)
General specification		
Cell combination	16 in series circuit	16 in series circuit
Cell assembly	3.2V130Ah	3.2V180Ah
Casing material	Aluminum Alloy	Aluminum Alloy
Weight	105.6lbs(47.9kg)	158.5lbs(71.9kg)
Dimension(L*W*H)	21.0*13.8*9.8in	30.8*12.8*9.3in
IP rate	IP66	IP66



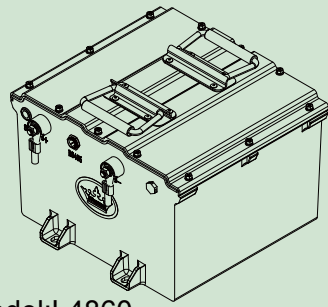

Model:L4860

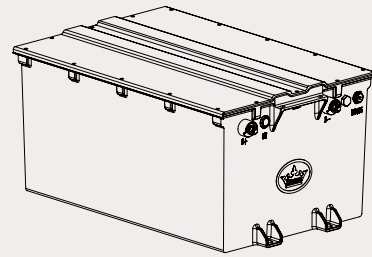
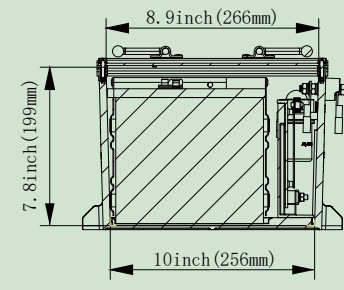
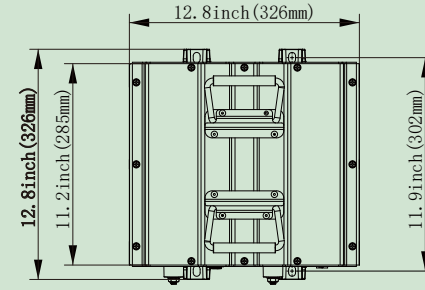
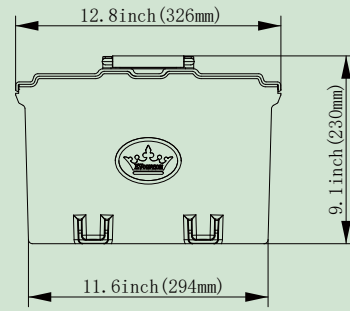

Model:L48110/L48130

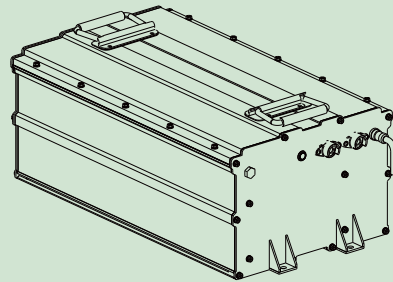
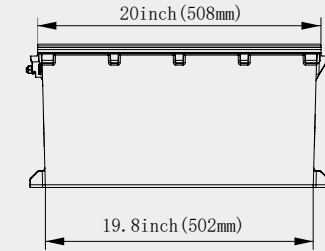
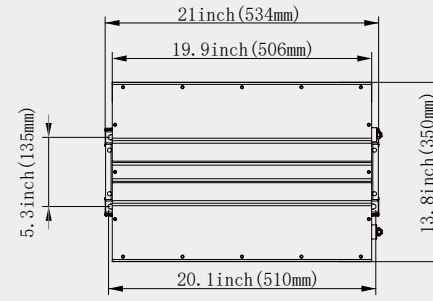
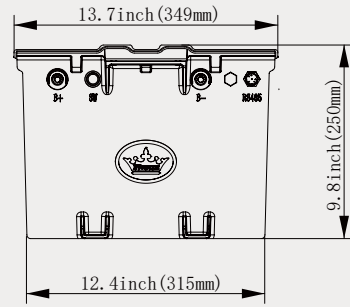

Model:L48180

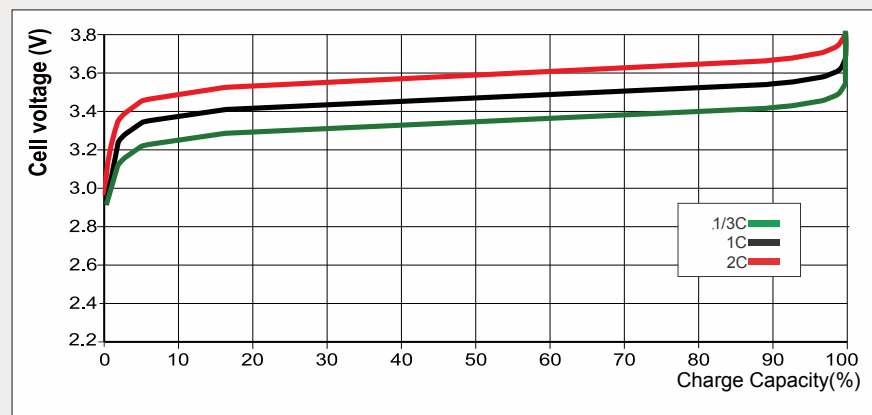
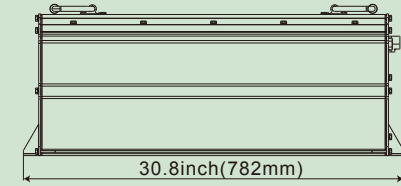
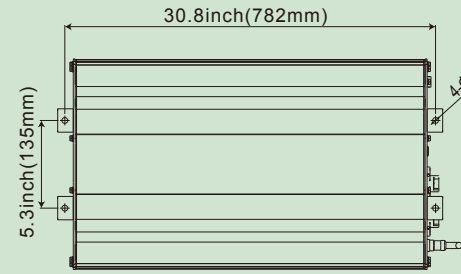
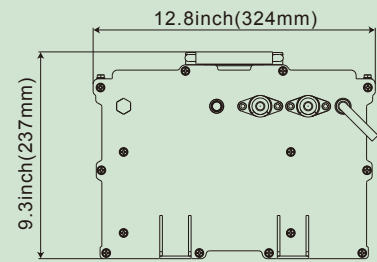

Charging Curve

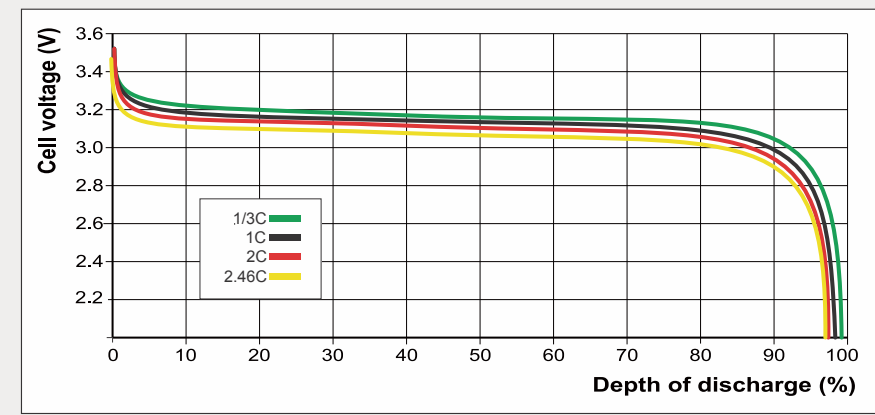



Discharging Curve



Individual Cell Monitoring & Balancing System



SoC, SoH, Voltage, Discharge/Charge Current, Life Cycle Monitoring



Adaptive input/output power controller



Quick Charging mode (optional)

Can be customized according to different applications

BMS Specifications

Battery SOC Indicator(BDI)

RS-485
RS485 Communication

Smart Charging

Higher restraint threshold(compared to competitive supplier),allow vehicle to handle steep/tough terrains without cutting off power (Protection mode)

Product Pictures

Continuous Current

Peak Current

Peak Current Duration

Time Between Peak Current

Over Charge, Over Discharge

Energy Management

EVOLUTION

200A

400A

30s

Not Limited

Quick charge ,Short period Over-current discharge

High Performance

COMPETITOR

100A

150A

can not work with high current discharge

Limited

Limited

Regular Performance



Aluminum pack

-  Long lasting aluminum casing
-  Rust resistant
-  Light weight
-  Water-proof
-  Impact resistant
-  Better heat dissipation
-  Increased life expectancy
-  Outstanding safety protection

A cell of a user-replaceable battery shall be in a rigid casing of sufficient strength to prevent flexing. A tool providing the mechanical advantage of a pliers, screwdriver, or hacksaw shall be the minimum capable of opening the user-replaceable cell casing, if opening of the casing will expose metallic lithium.

Iron Vs Aluminum Casing

Battery pack	Aluminum Casing(Evolution)	Iron Casing(Competitor)
Total Weight	Light	Heavy
Magnetic Properties	Non-Magnetic	Magnetic
Rusting And Corrosion	Excellent rust and corrosion resistance	Undergoes rusting because it is highly prone to corrosion
Oxidation States	Most stable oxidation	Non-stable oxidation
Electrical Conductivity	High	Low
Cost	High	Low

The casing of a lithium battery shall have the strength and rigidity necessary to resist the abuses to which it may be subjected, without resulting in a risk of fire. The casing of a user-replaceable lithium battery shall have the strength and rigidity necessary to resist the abuses to which it may be subjected without resulting in a risk of injury to persons.









Lead-acid vs. lithium-ion battery

















	EVOLUTION battery (48V 110Ah)	Lead-acid battery (48V 170Ah)
Cycle life expectation	>3500 times	<500 times
Lifetime	15 years	1 year
Charging time	Quick charge-1hour/ Standard charge-5 hours	12 hours
Charging frequency	No memory, charge anytime	Charge everyday after using
Safety	Multiple built-in protection	Gas inside may cause explosion
ECO friendly	No pollution	Lead is harmful
Cost effective	More benefits, requires less manhours	Less benefits, requires more manhours
Maintenance	No need	Regular water filling, maintenance, and checks
Weight	102.7lbs (46.6kg)/golf cart	397lbs (180kg)/golf cart

Five-year cost comparison

The design life of the golf cart batteries is 15 years and we offer a five-year warranty. Evolution EV batteries can save up to at least 70% expenditures for you in five years.

Below is the 5-year expenditure contrast table between Evolution lithium battery and lead-acid battery.

Purchases over five years	 Battery cost	 Maintenance	 Electricity waste	 Installation	 Shipping
	 \$	N/A	N/A		
	N/A	N/A	N/A	N/A	N/A
	N/A	N/A	N/A	N/A	N/A

5 YEAR LIMITED WARRANTY

Evolution Electric Vehicles("the Manufacturer") warrants each Evolution Lithium branded Lithium Iron Phosphate(LiFePO4) battery("the Battery") sold by Evolution Electric Vehicles or any of its authorized distributors or dealers, to be free of defects for 5 years("the Warranty Period") from the date of sale as determined by either the customer's sale receipt, the shipping invoice and/or the battery serial number, with proof of purchase. Within the 5 years of the Warranty Period, subject to the exclusions listed below, the Manufacturer will credit, replace and repair the Battery and/or the parts, if serviceable. If the components in question are determined to be defective in material or workmanship by manufacturer technicians or authorized technicians and the Manufacturer deems the components to be repairable, the Battery will be repaired and returned. If the Manufacturer deems the components to be not repairable, a new, similar Battery will be offered. The offer will be valid for 30 days after the date of notification. The Warranty period of any repaired Evolution Lithium battery product or its replacement is the remaining term of the Limited Warranty Period.

This Limited Warranty does not cover the labor cost of installation, removal, repair, replacement, or re-installation of a lithium battery pack or its components.

NON-TRANSFERABLE

This Limited Warranty is to the original purchaser of the Battery and is not transferable to any other person or entity. Please contact the place of purchase regarding any warranty claim.

WARRANTY DISCLAIMER

This warranty is in place of all other express warranties. The Manufacturer will not be liable for consequential or incidental damages. We make no warranty other than this limited warranty and expressly exclude any implied warranty including any warranty for consequential damages. This limited warranty is not transferable.

LEGAL RIGHTS

Some countries and/or states do not allow limitations on how long an implied warranty lasts or the exclusion or limitation of incidental or consequential damages, so the above limitations may not apply to you. This warranty gives you specific legal rights, which may vary from country to country and/or state to state. This warranty shall be governed by and interpreted by the laws. This warranty is understood to be the exclusive agreement between the parties relating to the subject matter hereof. No employee or representative of the Manufacturer is authorized to make any warranty in addition to those made in this agreement.

NON-EVOLUTION LITHIUM WARRANTIES

This Limited Warranty does not cover batteries sold by the Manufacturer or an authorized distributor or dealer to an Original Equipment Manufacturer("OEM"). Please contact the OEM directly for warranty claims regarding such Battery.

NON-WARRANTY REPAIRS

If outside of the Warranty period or for damage not covered under the Warranty, customers may still contact the Manufacturer for battery repairs. Costs include shipping, parts, and \$65 per hour labor.

SUBMITTING A WARRANTY CLAIM

To submit a warranty claim, please contact the original place of purchase. The Battery may be required to be shipped back to the Manufacturer for further inspection.

- Intelligent
- High Efficiency
- High Reliability
- Globally Used

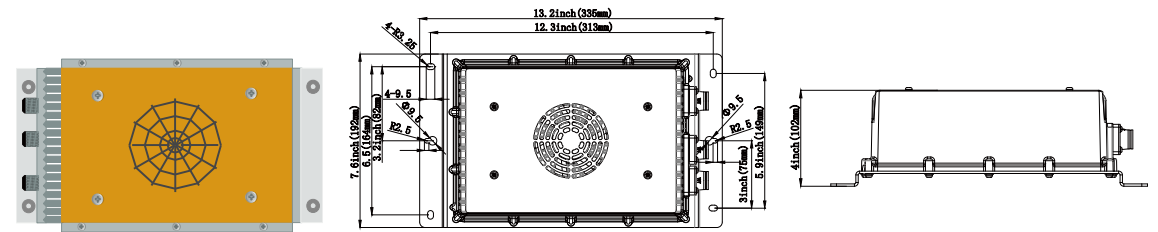

Charger specification

Battery pack rated voltage	48V
Maximum charger output	68V
AC input voltage range	85-270VAC; 45-65Hz
AC input current value	11.5A@120VAC; 6.1A@220VAC
Power factor	≥0.99
Charger efficiency	≥95%
Noise	≤45dB
IP Class	IP67
Weight	9.3lb(4.2kg)
Operating temperature	-86°F to 149°F(-30°C to 65°C)
Storage temperature	-104°F to 203°F(-40°C to 95°C)

Safety & Certification

- The application of active PFC, LLC and other new technologies;
- Reliable hardware protection and voltage, current self-check protection;
- Perfect charging strategy;
- Ensure the high safety of the charging process;
- Products fully comply with TUV, FCC, CEC, DOE, California 65 certification requirements.

Reliability

- The charger casing adopts integrated die-casting structure;
- The charger adopts the glue filling process;
- The active cooling fan is designed for long life span ,the charger is with potting structure;
- With high reliability of product engineering design and years of industry verification, the charger can adapt to harsh operating environment.